

REVISIONS			
REV	DESCRIPTION	DATE	APPROVED
XX	XX	MO/DY/YR	XXX

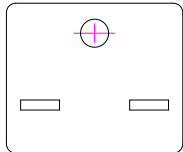

PIN AT TOP-OPTIONAL CONFIGURATION

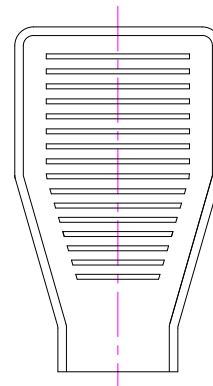
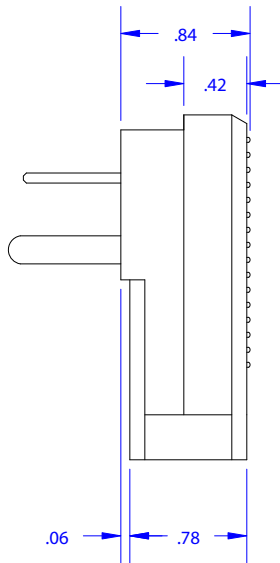
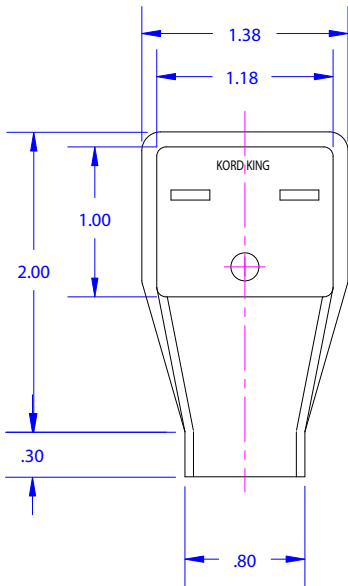

PROPRIETARY INFORMATION
KORD KING, INC.
ALL RIGHTS RESERVED

THIS DOCUMENT CONTAINS CONFIDENTIAL AND PROPRIETARY INFORMATION OF KORD KING AND ITS RECEIPT OR POSSESSION DOES NOT CONVEY ANY RIGHTS TO REPRODUCE, DISCLOSE ITS CONTENTS, OR TO MANUFACTURE, USE OR SELL ANYTHING IT MAY DESCRIBE. REPRODUCTION, DISCLOSURE, OR USE WITHOUT SPECIFIC WRITTEN AUTHORIZATION OF KORD KING IS STRICTLY FORBIDDEN.

TOLERANCES FRACTIONAL ± 1/8 2 PLACE DEC. ± 0.060 3 PLACE DEC. ± 0.030		KORD KING, INC.		
MATERIAL SPEC MATL: GRADE: THICK:				
SIZE A	FSCM NO.	DWG NO. KK15000-6-15	REV XX	
SCALE NONE	DRAWN BY: DATE DWN:	SHEET	1 OF 1	